

Composite dry sliding bushings, metric dimensions

Principal dimensions			Basic load ratings		Mass	Designation
d	D	B	dynamic C	static C0	kg	-
mm			kN			
25	28	20	38	120	0,018	PCM 252820 E

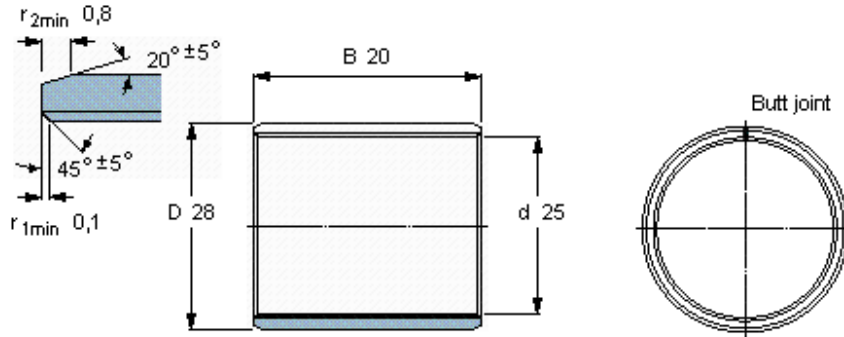

Specific load factor
Material constant

K 80
 K_M 480